

The CPM family of printed circuit board headers is used with the CPF and MRT3 pluggable terminal blocks. The CPM is available in both a vertical and 90 degree version and with either open or closed ends. A feature of the CPM header is the molded-in polarization that insures proper mating of the plug. The CPM headers are available in 2 to 24 positions and have a UL rating of 12 amps, 300 volts. The standard color is green, however other colors are available upon request.

### SPECIFICATIONS

Housing Material:	PA68 Polyamide, Flammable UL94V0
Housing Color:	Green
Pin:	Tin Plated Brass
PCB Mounting Hole:	1.6 mm
Nominal Current:	12A
Voltage:	300V
Temperature Range:	-30° C to 85° C

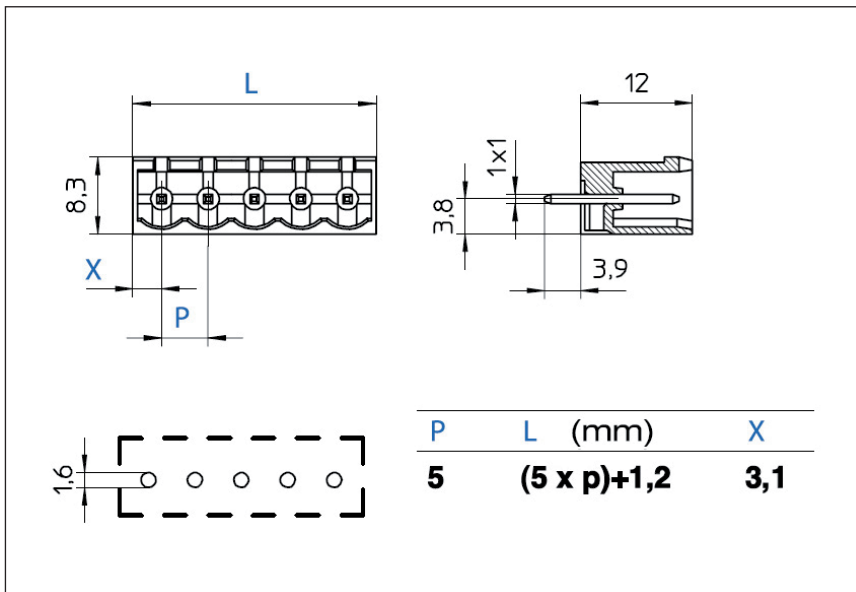
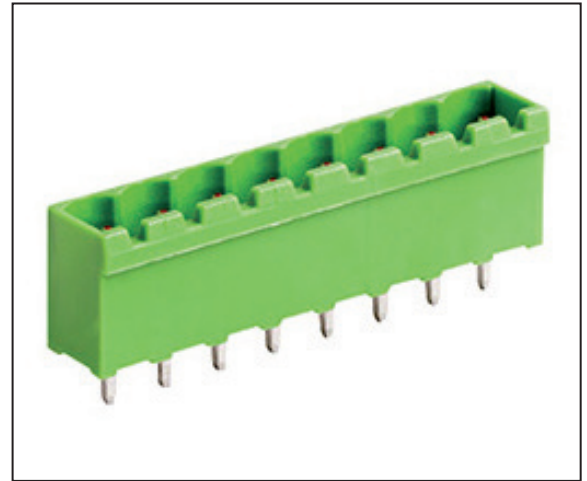

Item	No. of Poles	Length (mm)
CPM5.0	2	11.2
CPM5.0	3	16.2
CPM5.0	4	21.2
CPM5.0	5	26.2
CPM5.0	6	31.2
CPM5.0	7	36.2
CPM5.0	8	41.2
CPM5.0	9	46.2
CPM5.0	10	51.2
CPM5.0	11	56.2
CPM5.0	12	61.2
CPM5.0	13	66.2
CPM5.0	14	71.2
CPM5.0	15	76.2
CPM5.0	16	81.2
CPM5.0	17	86.2
CPM5.0	18	91.2
CPM5.0	19	96.2
CPM5.0	20	101.2
CPM5.0	21	106.2
CPM5.0	22	111.2
CPM5.0	23	116.2
CPM5.0	24	121.2